

Article number: 057153305404

Description: HEPCO GV3 bearing BHJ 54 E
Standard for Blind hole Fixing

Measures

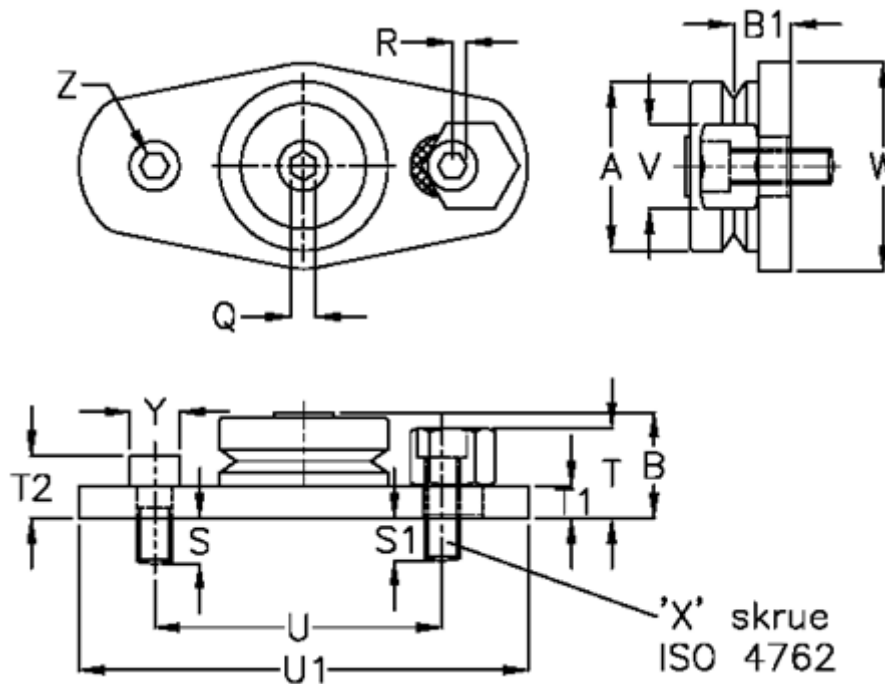

a = 54.0	T1 = 10.50	Y = 13.0
B = 34.7	T2 = 18.50	Z = 20
B1 = 19.00	U = 89.5	
Q = 8.0	U1 = 133.0	
R = 3.0	V = 25	
S = 14.50	W = 62.0	
S1 = 16.4	Weight kg/1000 = 1	
T = 23.5	X = M8	